

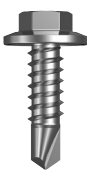

DRILLX[®]

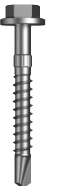

METAL

<p>METAL SDS FLANGED HEX</p>  <p>T9PM3FH</p> <p>CLASS 3 AS3566</p>	<p>METAL SDS FLANGED HEX</p>  <p>T9PMYFH</p> <p>ZYP AS3566</p>	<p>METAL SDS FLANGED HEX</p>  <p>T9PMZFH</p> <p>Z/P AS3566</p>	
<p>METAL SDS FLANGED HEX</p>  <p>T9PM4FH</p> <p>CLASS 4 AS3566</p>	<p>METAL SDS FLANGED HEX 5/16AF</p>  <p>T9PM3RH</p> <p>CLASS 3 AS3566</p>	<p>METAL SDS FLANGED HEX + SEAL WASHER</p>  <p>T9PM4SH</p> <p>CLASS 4 AS3566</p>	<p>EPDM SEAL WASHER FLUTED</p>  <p>TXW9PEFS</p> <p>PLAIN</p>
<p>METAL SDS FLANGED HEX + SEAL WASHER</p>  <p>T9PM4SS</p> <p>CLASS 4 AS3566</p>	<p>METAL SDS FLANGED HEX + SEAL WASHER</p>  <p>T9PM4XS</p> <p>CLASS 4 AS3566</p>	<p>METAL SDS FLANGED HEX + SEAL WASHER</p>  <p>T9PM4XH</p> <p>CLASS 4 AS3566</p>	<p>METAL SDS FLANGED HEX</p>  <p>T9PM4FS</p> <p>CLASS 4 AS3566</p>

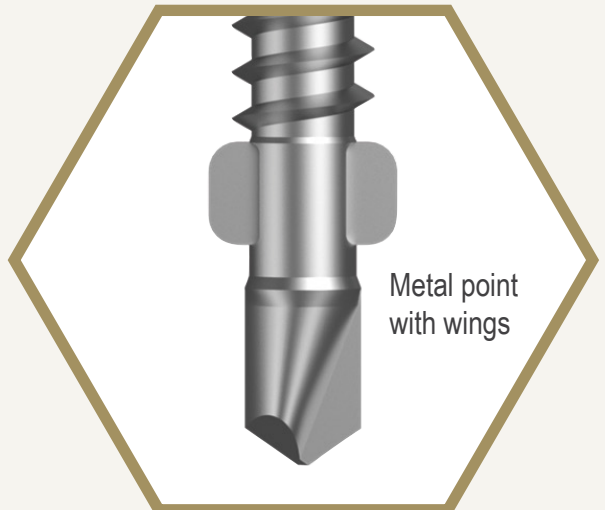



NEW METAL SDS WAFER PHILLIPS

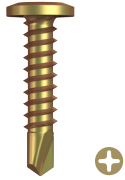

T9PMYWP

ZYP
AS3566

METAL SDS BUGLE BATTEN RIBBED SQUARE



T9PM3BQ

CLASS 3
AS3566

NEW METAL SDS BUGLE PHILLIPS



FLT9PMLBP

B-PH
AS3566

Collated screws



To be used with all auto-feed collated screw guns.

METAL SDS MINI LOW-PROFILE PHILLIPS



T9PM3MP

CLASS 3
AS3566

NEW METAL SDS FLAT SQUARE



T04MSLQ

304
STAINLESS STEEL
USE WITH ALUM

NEW METAL SERRATED FLAT FRAMING PHILLIPS



T9PMKEP

E-COAT
BLACK
AS3566

NEW METAL SUPER FLAT FRAMING PHILLIPS



T9PMKNP

E-COAT
BLACK
AS3566

METAL SDS CSK PHILLIPS



T9PMYCP

ZYP
AS3566

METAL SDS CSK PHILLIPS

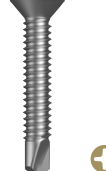

T9PM3CP

CLASS 3
AS3566

METAL SDS CSK RIBBED PHILLIPS



T9PMYRP

ZYP
AS3566

METAL SDS CSK RIBBED PHILLIPS



T9PM3RP

CLASS 3
AS3566

METAL SDS PAN PHILLIPS

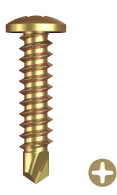

T9PMYPP

ZYP
AS3566

METAL SDS BUGLE PHILLIPS

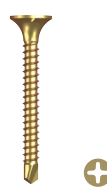

T9PMYBP

ZYP
AS3566

METAL SDS BUGLE PHILLIPS

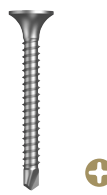

T9PMZBP

Z/P
AS3566

METAL SDS BUGLE BATTEN RIBBED INTERNAL HEX



T9PM3BH

CLASS 3
AS3566

METAL SDS WAFER PHILLIPS

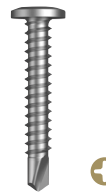

T9PM3WP

CLASS 3
AS3566

METAL SDS BUGLE PHILLIPS

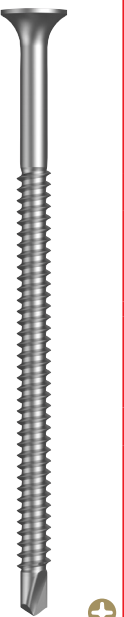

T9PM3BP

CLASS 3
AS3566

METAL SDS BUTTON WAFER PHILLIPS



T9PMYAP

ZYP
AS3566

METAL SDS BUTTON WAFER PHILLIPS



T9PM3AP

CLASS 3
AS3566

METAL SDS FLAT PHILLIPS

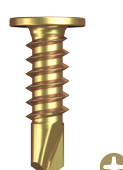

T9PMYLP

ZYP
AS3566

METAL SDS FLAT PHILLIPS

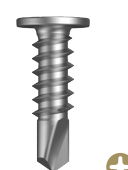

T9PM3LP

CLASS 3
AS3566

METAL SDS FLOWER SELF-EMBED PHILLIPS



T9PMYOP

ZYP
AS3566

METAL SDS PAN TRILOBULAR



T9PM3PI

CLASS 3
AS3566



METAL

METAL WINGS
FLOWER
SELF-EMBED
SQUARE

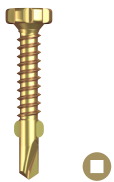

T9PGYOQ

ZYP
AS3566

METAL WINGS
CSK RIBBED
SQUARE



T9PG3RQ

CLASS 3
AS3566

METAL WINGS
CSK
SELF-EMBED
INTERNAL HEX



T9PG3SI

CLASS 3
AS3566

METAL WINGS
CSK RIBBED
SQUARE

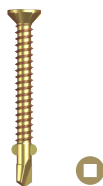

T9PGYRQ

ZYP
AS3566

S500 WINGS
CSK RIBBED
PHILLIPS



T9PHYRP

ZYP
AS3566

S500 SDS
FLANGED HEX

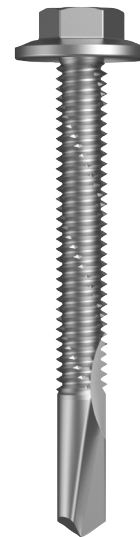

T9P54FH

CLASS 4
AS3566

S500 SDS
FLANGED HEX
+ SEAL WASHER

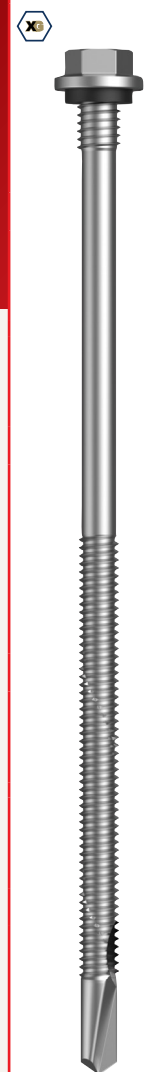

T9P54XH

CLASS 4
AS3566

NEW METAL
SDS HEX POLY
ALL-IN-1



T9PM4PA

CLASS 4
AS3566

Expansion
hole cutter



All in 1 Polycarbonate Roofing Screw



Sealing
washer

S500 SDS
FLANGED HEX
+ SEAL WASHER



T9P54SH

CLASS 4
AS3566

S500 SDS
WAFFER
PHILLIPS



T9P53WP

CLASS 3
AS3566

METAL SDS
CYCLONE
MULTISEAL



T9PM4YM

CLASS 4
AS3566

S500 SDS
CYCLONE
MULTISEAL



T9P54YM

CLASS 4
AS3566

CYCLONE MULTISEAL
WASHER

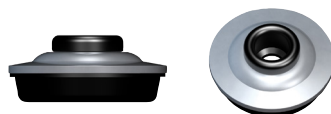

TXW9PYM

PLAIN
SUIT #14 SCREW

Colorbond®

Cyclone washer is
available in Colorbond®
range of colours p.163

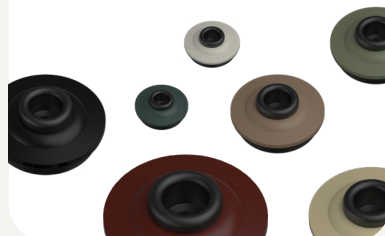



Screw Terminology

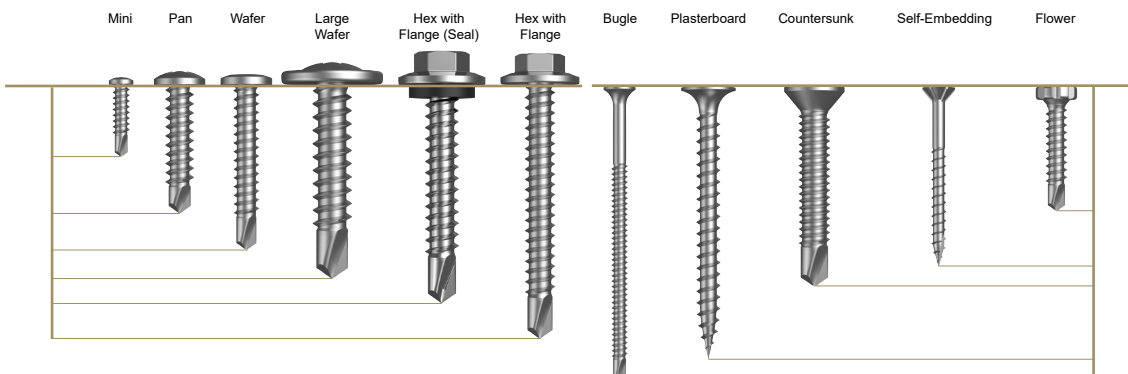
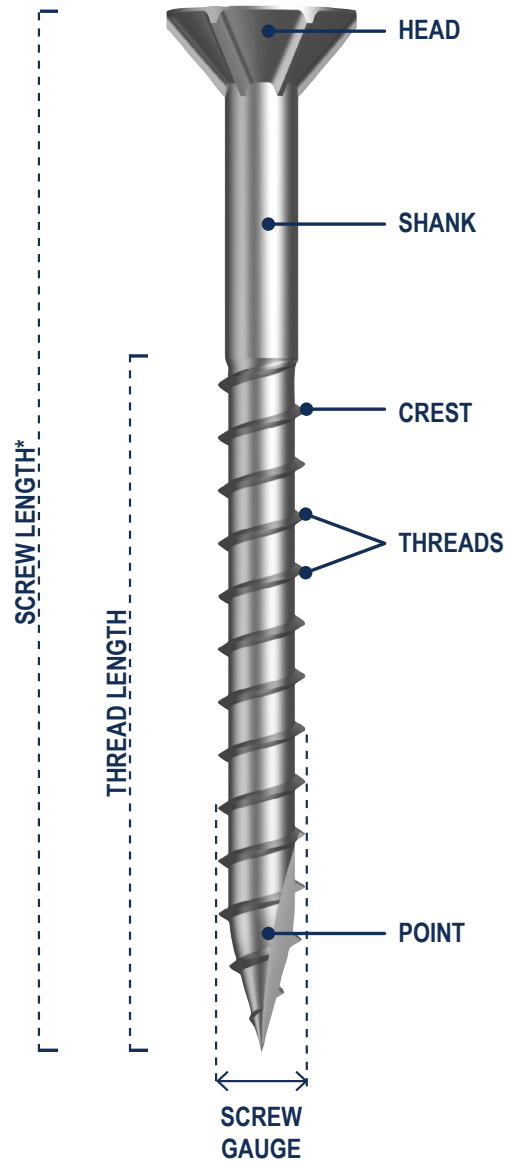

*SCREW TYPES TO MEASURE FROM THE UNDERSIDE OF THE HEAD

*SCREW TYPES TO MEASURE FROM THE TOP OF THE HEAD

KEY

Z/P
ZINC PLATED
(RoHS COMPLIANT)

ZYP
ZINC YELLOW
PASSIVATE

B-PH
BLACK
PHOSPHATE

CL3
CLASS 3

CL4
CLASS 4

R10
R1000 HOURS
PROTECTIVE COAT

ZP BLK
ZINC BLACK
PASSIVATE

TYK
TYKOTE

E-BLK
E-COAT BLACK

PLN
PLAIN

ALLOY
ALLOY STEEL

S2A
S2 ALLOY STEEL

S2B
S2 ALLOY STEEL
BLACK

S2T
S2 ALLOY STEEL
TITAN

ALUM
ALUMINIUM



Bi-Fix®

METAL SDS HEX HEAD

304 **Bi-Fix**



T4MXHH

BI-METAL
304 STAINLESS STEEL

METAL SDS PAN PHILLIPS

304 **Bi-Fix**



T4XMPP

BI-METAL
304 STAINLESS STEEL

METAL SDS PAN SQUARE

304 **Bi-Fix**

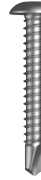

T4MXPQ

BI-METAL
304 STAINLESS STEEL

METAL SDS WAFER PHILLIPS

304 **Bi-Fix**



T4MXWP

BI-METAL
304 STAINLESS STEEL

METAL WINGS CSK RIBBED SQUARE

304 **Bi-Fix**

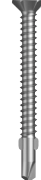

T4XGXRQ

BI-METAL
304 STAINLESS STEEL

S500 WINGS CSK RIBBED SQUARE

304 **Bi-Fix**

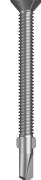

T4XHRQ

BI-METAL
304 STAINLESS STEEL

S500 SDS FLANGED HEX

304 **Bi-Fix**



T4X5XFH

BI-METAL
304 STAINLESS STEEL

METAL SDS ALUMINIUM SEAL HEX

304 **Bi-Fix**



T4MXAH

BI-METAL
304 STAINLESS STEEL

NEW METAL SDS HEX HEAD

316 **Bi-Fix**



T6MXHH

BI-METAL
316 STAINLESS STEEL

METAL SDS WAFER SQUARE

316 **Bi-Fix**



T6MXWQ

BI-METAL
316 STAINLESS STEEL

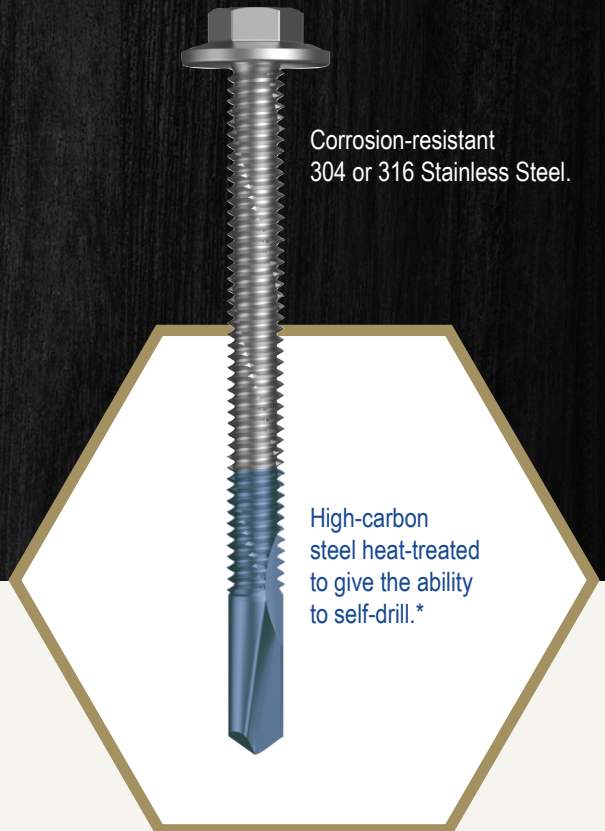

Corrosion-resistant
304 or 316 Stainless Steel.

High-carbon steel heat-treated to give the ability to self-drill.*

*Point colour for illustration purposes only.

A bi-metallic screw is comprised of two metal types. The point is manufactured from high-carbon steel that is heat-treated to give it the ability to self-drill. The head section is made from a corrosion-resistant stainless steel (304 or 316). The two metals are 'fused' to form a screw that offers excellent self-drilling properties, combined with exceptional corrosion resistance.



vmaX®

SDS TRIM HEAD TORX

304 **vmaX**

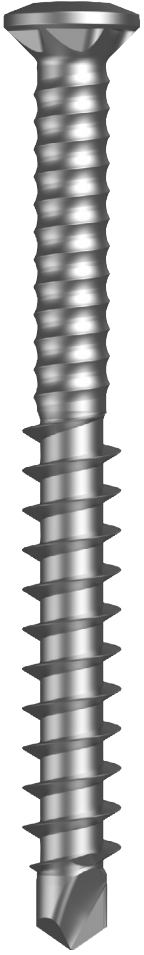

T04VSTT

304 STAINLESS STEEL

SDS FLANGED HEX + SEAL WASHER

vmaX

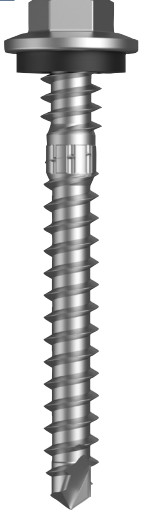

T9PV4XS

CLASS 4 AS3566

SDS BATTEN FLANGED HEX

vmaX



T9PV3FH

CLASS 3 AS3566

SDS FLANGED HEX + SEAL WASHER

vmaX



T9PV4SH

CLASS 4 AS3566



vmaX® feature a universal drilling point and are suitable for fastening roof sheeting to thin metal battens, timber trusses and steel purlins up to 1.9mm thick.



TIMBER

<p>TYPE 17 CSK RIBBED SQUARE</p>  <p>T04WS6Q</p> <p>304 STAINLESS STEEL</p>	<p>TYPE 17 BUGLE BATTEN RIBBED INTERNAL HEX</p>  <p>T04WSBH</p> <p>304 STAINLESS STEEL</p>	<p>NEW TYPE 17 PAN POZI</p>  <p>T04WSPZ</p> <p>304 STAINLESS STEEL</p>	<p>NEW TYPE 17 FLANGED HEX 5/16AF PIT SCREW</p>  <p>T04WSRH</p> <p>304 STAINLESS STEEL</p>	<p>TYPE 17 TRIM RIBBED SQUARE</p>  <p>T04WSTQ</p> <p>304 STAINLESS STEEL</p>		
<p>TYPE 17 TRIM RIBBED SQUARE</p>  <p>T04WSTD</p> <p>304 STAINLESS STEEL</p>	<p>TDX®</p> <p>Trim head for a neat finish and No.1 square drive to prevent bit cam out.</p> <p>Square thread for greater holding power, preventing the deck from lifting.</p> 		<p>TYPE 17 BUGLE BATTEN RIBBED INTERNAL HEX</p>  <p>T16WSBH</p> <p>316 STAINLESS STEEL</p>		<p>TYPE 17 BUGLE BATTEN RIBBED SQUARE</p>  <p>T16WSBQ</p> <p>316 STAINLESS STEEL</p>	
<p>TYPE 17 FLANGED HEX</p>  <p>T16WSFH</p> <p>316 STAINLESS STEEL</p>	<p>TYPE 17 FLANGED HEX + SEAL WASHER</p>  <p>T16WSSH</p> <p>316 STAINLESS STEEL</p>	<p>TYPE 17 SELF-EMBED SQUARE</p>  <p>T16WSSQ</p> <p>316 STAINLESS STEEL</p>	<p>TYPE 17 BUTTON SQUARE</p>  <p>T16WSUQ</p> <p>316 STAINLESS STEEL</p>	<p>NEW TYPE 17 WAFFER PHILLIPS</p>  <p>T16WSPW</p> <p>316 STAINLESS STEEL</p>	<p>TYPE 17 BUGLE BATTEN RIBBED INTERNAL HEX</p>  <p>T9PW3BH</p> <p>CLASS 3 AS3566</p>	<p>TYPE 17 CSK PHILLIPS</p>  <p>T9PW3CP</p> <p>CLASS 3 AS3566</p>



TYPE 17 FLANGED HEX



T9PW3FS

CLASS 3
AS3566

Scratchguard®

This design feature improves resistance to corrosion by protecting the fastener shank from severe scratching or scouring, which can occur when fixing metal roofing.

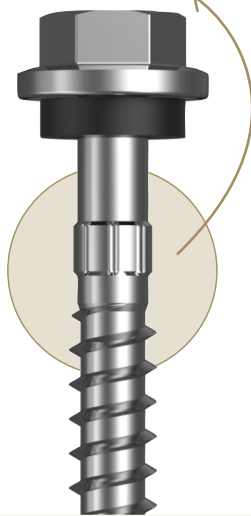

TYPE 17 WASHER HEAD INTERNAL HEX

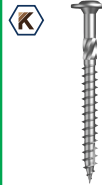

T9PW3GI

CLASS 3
AS3566

TYPE 17 WAFFER PHILLIPS

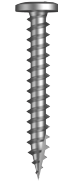

T9PW3WP

CLASS 3
AS3566

NEW TYPE 17 BUGLE BATTEN RIBBED

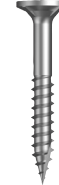

T9PW4BH

CLASS 4
AS3566

TYPE 17 FLANGED HEX

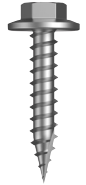

T9PW4FH

CLASS 4
AS3566

TYPE 17 FLANGED HEX

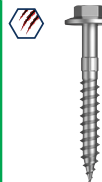

T9PW4FS

CLASS 4
AS3566

NEW TYPE 17 HEX POLY ALL-IN-1



T9PW4PA

CLASS 4
AS3566

TYPE 17 FLANGED HEX + SEAL WASHER

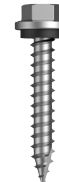

T9PW4SH

CLASS 4
AS3566

TYPE 17 FLANGED HEX + SEAL WASHER

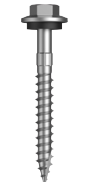

T9PW4SS

CLASS 4
AS3566

TYPE 17 FLANGED HEX + SEAL WASHER

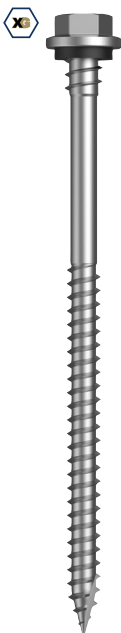

T9PW4XH

CLASS 4
AS3566

XGRIP®

A feature used to hold the roofing tight against the seal, ensuring a watertight seal even when the roof is walked upon.

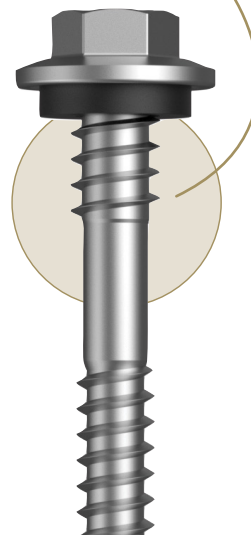

TYPE 17 FLANGED HEX + SEAL WASHER



T9PW4XS

CLASS 4
AS3566

TYPE 17 CYCLONE MULTISEAL



T9PW4YM

CLASS 4
AS3566

TYPE 17 WASHER HEAD INTERNAL HEX

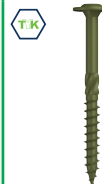

T9PWTGI

TYKOTE
HEC

TYPE 17 WASHER HEAD TORX

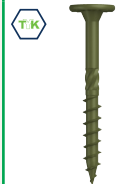

T9PWTGO

TYKOTE
HEC

TYPE 17 BUGLE BATTEN RIBBED INTERNAL HEX



T9PWYBH

ZYP
AS3566

TYPE 17 CSK PHILLIPS



T9PWYCP

ZYP
AS3566

TYPE 17 FLANGED HEX

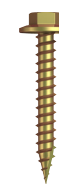

T9PWYFH

ZYP
AS3566

TYPE 17 PAN PHILLIPS

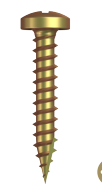

T9PWYPP

ZYP
AS3566



MULTI-USE

NEEDLE POINT CSK RIBBED SQUARE



T04NS4Q

304
STAINLESS STEEL

TREATED PINE SELF-EMBED SQUARE



T9PD3SQ

CLASS 3
AS3566

CHIPBOARD CSK RIBBED PHILLIPS



T9PDYRP

ZYP
AS3566

NEEDLE POINT BUTTON SQUARE

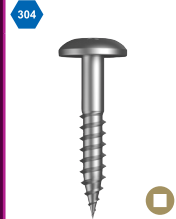

T04NSUQ

304
STAINLESS STEEL

NEW NEEDLE POINT BUGLE PLASTERBOARD PHILLIPS



FLT9PCLBP

B-PH
AS3566
COARSE

Collated screws

To be used with all auto-feed collated screw guns.

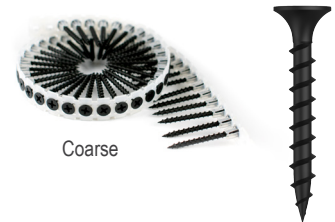

Coarse

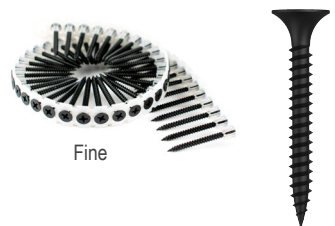

Fine

NEEDLE POINT LARGE WAFER METAL STITCH PHILLIPS

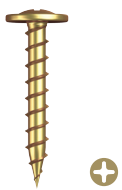

T9PCYAP

ZYP
AS3566
COARSE

NEEDLE POINT BUGLE PLASTERBOARD PHILLIPS

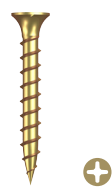

T9PCYBP

ZYP
AS3566
COARSE

NEEDLE POINT LARGE WAFER METAL STITCH PHILLIPS

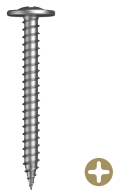

T9PN3AP

CLASS 3
AS3566

TYPE A BUTTON POST TORX



T9PA3BT

CLASS 3
AS3566

NEW NEEDLE POINT BUGLE PLASTERBOARD PHILLIPS



FLT9PNLBP

B-PH
AS3566

NEEDLE POINT FLAT PHILLIPS



T9PN3LP

CLASS 3
AS3566

NEEDLE POINT FLANGED HEX METAL STITCH



T9PN4FH

CLASS 4
AS3566

NEEDLE POINT FLANGED HEX + SEAL WASHER METAL STITCH

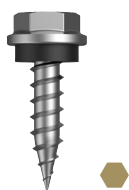

T9PN4SH

CLASS 4
AS3566

NEEDLE POINT LARGE WAFER METAL STITCH PHILLIPS

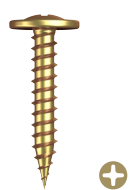

T9PNYAP

ZYP
AS3566

NEEDLE POINT BUGLE PLASTERBOARD PHILLIPS

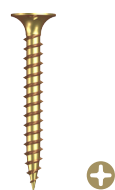

T9PNYBP

ZYP
AS3566

NEEDLE POINT FLAT PHILLIPS



T9PNYLP

ZYP
AS3566

NEEDLE POINT SELF-EMBED PHILLIPS

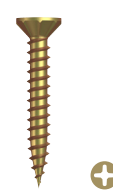

T9PNYSP

ZYP
AS3566



Framing Screws

**NEW
SERRATED
FLAT FRAMING
PHILLIPS**



T9PFKEP

E-COAT
BLACK
AS3566

**NEW METAL
SERRATED
FLAT FRAMING
PHILLIPS**



T9PMKEP

E-COAT
BLACK
AS3566

**NEW METAL
SUPER
FLAT FRAMING
PHILLIPS**



T9PMKNP

E-COAT
BLACK
AS3566

**NEEDLE POINT
FLAT
PHILLIPS**

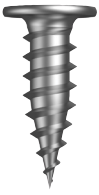

T9PN3LP

CLASS 3
AS3566

**NEEDLE POINT
FLAT
PHILLIPS**



T9PNYLP

ZYP
AS3566

**METAL SDS
FLAT
PHILLIPS**

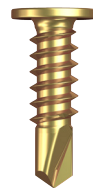

T9PMYLP

ZYP
AS3566

**TRUSS
FRAMING
FLANGED HEX**



T9PF3FH

CLASS 3
HEC

**HVAC BLUNT
POINT WASHER
HEX**

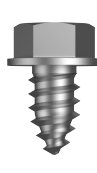

T9PFZWH

Z/P
HEC



Extended thread to the tip of the point allows easy start and alignment.



jmax™

Engineered point for self-drilling and fixing metal plate to timber without splitting.



SDS FLANGED HEX
jmax

T9PJ3FH1410030
 CLASS 3
 AS3566
 YELLOW

SDS FLANGED HEX
jmax

T9PJ3FH1410065
 CLASS 3
 AS3566
 BLUE

ALL-IN-1

Polycarb Assemblies

NEW METAL SDS HEX POLY ALL-IN-1

T9PM4PA
 CLASS 4
 AS3566

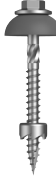
NEW TYPE 17 HEX POLY ALL-IN-1

T9PW4PA
 CLASS 4
 AS3566

Large domed sealing washer to support and seal polycarbonate roofing.



Head

Cutter



Expansion hole cutter creates a thermal expansion hole in the roofing sheet.



TYKOTE®

TYPE 17
WASHER HEAD
INTERNAL HEX

TYKOTE.



T9PWTGI

TYKOTE
HEC



TYPE 17
WASHER HEAD
TORX

TYKOTE.



T9PWTGO

TYKOTE
HEC











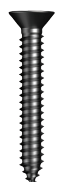
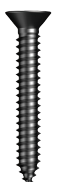
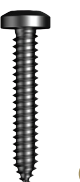
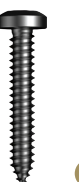
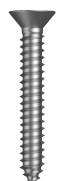
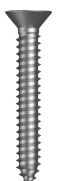
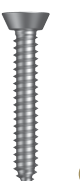
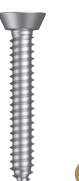
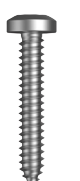
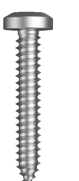
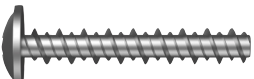











A high-performance coating specially formulated for resisting treated pine chemicals.





Self-Tapping Screws

<p>SELF-TAPPER CSK PHILLIPS</p>  <p>T9PSVCP</p> <p>ZP BLK ANSI B18.6.4 TYPE AB</p>	<p>SELF-TAPPER CSK SQUARE</p>  <p>T9PSVCQ</p> <p>ZP BLK ANSI B18.6.4 TYPE AB</p>	<p>SELF-TAPPER PAN PHILLIPS</p>  <p>T9PSVPP</p> <p>ZP BLK ANSI B18.6.4 TYPE AB</p>	<p>SELF-TAPPER PAN SQUARE</p>  <p>T9PSVPQ</p> <p>ZP BLK ANSI B18.6.4 TYPE AB</p>
<p>SELF-TAPPER CSK PHILLIPS</p>  <p>T9PSZCP</p> <p>Z/P ANSI B18.6.4 TYPE AB</p>	<p>SELF-TAPPER CSK SQUARE</p>  <p>T9PSZCQ</p> <p>Z/P ANSI B18.6.4 TYPE AB</p>	<p>SELF-TAPPER UNDERCUT CSK PHILLIPS</p>  <p>T9PSZDP</p> <p>Z/P ANSI B18.6.4 TYPE AB</p>	<p>SELF-TAPPER UNDERCUT CSK SQUARE</p>  <p>T9PSZDQ</p> <p>Z/P ANSI B18.6.4 TYPE AB</p>
<p>SELF-TAPPER PAN PHILLIPS</p>  <p>T9PSZPP</p> <p>Z/P ANSI B18.6.4 TYPE AB</p>	<p>SELF-TAPPER PAN SQUARE</p>  <p>T9PSZPQ</p> <p>Z/P ANSI B18.6.4 TYPE AB</p>	<p>ELECTRICAL PANEL SCREW PHILLIPS</p>  <p>T9PPZAP</p> <p>Z/P HEC</p>	

SCREW HEAD & SEAL STYLES			
Head	Seal Style	Head	Seal Style
	Hex Flange Head		Wafer
	Countersunk		Button Head
	Countersunk Ribbed		Flat Head
	Undercut Countersunk		Flat Serrated
	Bugle		Washer Head
	Bugle Batten Ribbed		Large Washer Head
	Trim Head Ribbed		Flower
	Pan Head		Hex Head with Seal
	Mini Pan		Hex Head with EPDM Seal
	Large Wafer		Hex Head with Multiseal



DECK MASTER[®]



BRANDS

Find the NEW Deck Master range in our Brands section at hobson.com.au



A range of screws that suit all decking applications in any environment.

METAL SDS BUGLE BATTEN RIBBED INTERNAL HEX

T9PM3BH

CLASS 3
AS3566

METAL WINGS CSK RIBBED SQUARE

T9PG3RQ

CLASS 3
AS3566

METAL SDS BUGLE BATTEN RIBBED SQUARE

T9PM3BQ

CLASS 3
AS3566

SDS WINGS CSK RIBBED SQUARE

T4XGXRQ

304
STAINLESS STEEL

S500 WINGS CSK RIBBED SQUARE

T4XHRQ

304
STAINLESS STEEL

SDS TRIM HEAD TORX

T04VSTT

304
STAINLESS STEEL

TYPE 17 TRIM RIBBED SQUARE

T04WSTD

304
STAINLESS STEEL

TYPE 17 CSK RIBBED SQUARE

T04WS6Q

304
STAINLESS STEEL

TYPE 17 TRIM RIBBED SQUARE

T04WSTQ

304
STAINLESS STEEL

TYPE 17 BUGLE BATTEN RIBBED INTERNAL HEX

T04WSBH

304
STAINLESS STEEL

TYPE 17 BUGLE BATTEN RIBBED SQUARE

T16WSBQ

316
STAINLESS STEEL

TYPE 17 BUGLE BATTEN RIBBED INTERNAL HEX

T16WSBH

316
STAINLESS STEEL

TYPE 17 SELF-EMBED SQUARE

T16WSSQ

316
STAINLESS STEEL

TYPE 17 BUGLE BATTEN RIBBED INTERNAL HEX

T9PW3BH

CLASS 3
AS3566

TYPE 17 BUGLE BATTEN RIBBED INTERNAL HEX

T9PWYBH

ZYP
AS3566

TYPE 17 WASHER HEAD INTERNAL HEX

T9PW3GI

CLASS 3
AS3566

NEEDLE POINT CSK RIBBED SQUARE

T04NS4Q

304
STAINLESS STEEL

TREATED PINE SELF-EMBED SQUARE

T9PD3SQ

CLASS 3
AS3566

CHIPBOARD CSK RIBBED PHILLIPS

T9PDYRP

ZYP
AS3566



DRILLX[®]



Colorbond[®]

Hobson Screws, Rivets
and Cyclone Washers
with painted heads
in the Colorbond[®]
range of colours.



T9PM4FH1016016
PLAIN HEAD

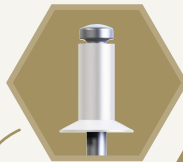

Also in the rivet
and cyclone washer
ranges.



Painted Heads

To find a rivet or screw in
any of the colours below,
simply replace the **9P** in
the part number with the
colour **Code** in the table.



TDWM4FH1016016
DOVER WHITE HEAD



COLORBOND® COLOUR MATRIX

Code	Colour Name	Colour	Code	Colour Name	Colour
DW	Dover White™		NS	Night Sky®	NZ EBONY
SM	Surfmist®	NZ TITANIA	IS	Ironstone®	
EH	Evening Haze®		DO	Deep Ocean®	NZ STORM BLUE
CC	Classic Cream™	NZ SMOOTH CREAM	CG	Cottage Green®	NZ PERMANENT GREEN
PA	Paperbark®		PE	Pale Eucalypt®	NZ MIST GREEN
CO	Cove®		TE	Terrain®	
DU	Dune®		MR	Manor Red®	NZ SCORIA
SO	Southerly®		↓ Discontinued Colours ↓ Screws painted upon request		
SG	Shale Grey™	NZ GULL GREY	BU	Bushland®	
BG	Bluegum®		WI	Wilderness®	NZ RIVERGUM
WN	Windspray®	NZ SMOKEY	LO	Loft®	
MA	Mangrove®		HE	Headland®	NZ MAPLE
GU	Gully®		SA	Sandbank®	NZ STRAW
JA	Jasper®	NZ SORRELL	PT	Pale Terracotta™	
WA	Wallaby®		BR	Blue Ridge®	NZ PACIFIC BLUE
BA	Basalt®		PL	Plantation®	
WG	Woodland Grey®	NZ THUNDER GREY	PR	Primrose™	
MO	Monument®		ST	Stone®	NZ RIVERSAND

NZ colours available on request.

*Colours are representative only.

Colorbond® is a registered trademark of BlueScope Steel Limited.







impaX[®]





Find security socket bits in **STAINLESS FASTENERS** category.







Drive bits designed for high-impact forces of modern power tools.

<p>INSERT HEX</p> <p>impaX</p>  <p>TXDIIHX</p> <p>DRIVE BIT 1/4 S2 ALLOY STEEL BLACK</p>	<p>INSERT PHILLIPS</p> <p>impaX</p>  <p>TXDIIPH</p> <p>DRIVE BIT 1/4 S2 ALLOY STEEL BLACK</p>	<p>INSERT SQUARE</p> <p>impaX</p>  <p>TXDIISQ</p> <p>DRIVE BIT 1/4 S2 ALLOY STEEL BLACK</p>	<p>POWER HEX</p> <p>impaX</p>  <p>TXDIPHX</p> <p>DRIVE BIT 1/4 S2 ALLOY STEEL BLACK</p>	<p>POWER PHILLIPS</p> <p>impaX</p>  <p>TXDIPPH</p> <p>DRIVE BIT 1/4 S2 ALLOY STEEL BLACK</p>
---	--	--	--	--

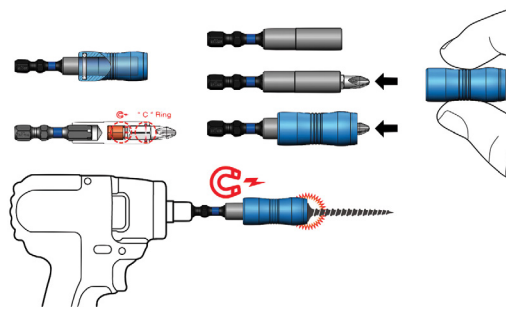
<p>MAGNETIC NUT SETTER</p> <p>impaX</p>  <p>TXDIPNS</p> <p>DRIVE BIT 1/4 S2 ALLOY STEEL BLACK</p>	<p>INSERT BIT HOLDER</p> <p>impaX</p>  <p>TXDIIBH</p> <p>DRIVE BIT 1/4 S2 ALLOY STEEL BLACK</p>	<p>INSERT BIT HOLDER MAG COLLAR</p> <p>impaX</p>  <p>TXDIIBM</p> <p>DRIVE BIT 1/4 S2 ALLOY STEEL BLACK</p>
---	---	--

Mag Collar





<p>POWER SQUARE</p> <p>impaX</p>  <p>TXDIPSQ</p> <p>DRIVE BIT 1/4 S2 ALLOY STEEL BLACK</p>	<p>POWER TORX</p> <p>impaX</p>  <p>TXDIPTX</p> <p>DRIVE BIT 1/4 S2 ALLOY STEEL BLACK</p>	<p>SDS PLUS ADAPTOR</p> <p>impaX</p>  <p>TXDIPAI</p> <p>DRIVE BIT 1/4 CHROME PLATED MATT FINISH</p>
--	--	---



KEY	
	PHILLIPS
	HEX INT
	HEX EXT
	SQUARE
	TORX
	SLOTTED
	TRIOBULAR
	SDS-PLUS
	SDS-MAX



<p>INSERT PHILLIPS</p>  <p>TXDTIPH</p> <p>DRIVE BIT 1/4 S2 ALLOY TITANIUM NITRIDE</p>	<p>POWER HEX</p>  <p>TXDTPHX</p> <p>DRIVE BIT 1/4 S2 ALLOY TITANIUM NITRIDE</p>	<p>POWER PHILLIPS</p>  <p>TXDTPPH</p> <p>DRIVE BIT 1/4 S2 ALLOY TITANIUM NITRIDE</p>	<p>DOUBLE ENDED PHILLIPS</p>  <p>TXDDDPH</p> <p>DRIVE BIT 1/4 S2 ALLOY STEEL STANDARD</p>	<p>INSERT BIT HOLDER</p>  <p>TXDDIBH</p> <p>DRIVE BIT 1/4 S2 ALLOY STEEL STANDARD</p>	<p>INSERT HEX</p>  <p>TXDDIHX</p> <p>DRIVE BIT 1/4 S2 ALLOY STEEL STANDARD</p>	<p>INSERT PHILLIPS PLASTERBOARD</p>  <p>TXDDIPD</p> <p>DRIVE BIT 1/4 S2 ALLOY STEEL STANDARD</p>
<p>INSERT PHILLIPS</p>  <p>TXDDIPH</p> <p>DRIVE BIT 1/4 S2 ALLOY STEEL STANDARD</p>	<p>INSERT SLOTTED</p>  <p>TXDDISL</p> <p>DRIVE BIT 1/4 S2 ALLOY STEEL STANDARD</p>	<p>INSERT SQUARE</p>  <p>TXDDISQ</p> <p>DRIVE BIT 1/4 S2 ALLOY STEEL STANDARD</p>	<p>POWER HEX</p>  <p>TXDDPHX</p> <p>DRIVE BIT 1/4 S2 ALLOY STEEL STANDARD</p>	<p>MAGNETIC NUT SETTER</p>  <p>TXDDPNS</p> <p>DRIVE BIT 1/4 S2 ALLOY STEEL STANDARD</p>	<p>POWER PHILLIPS</p>  <p>TXDDPPH</p> <p>DRIVE BIT 1/4 S2 ALLOY STEEL STANDARD</p>	<p>POWER SLOTTED</p>  <p>TXDDPSL</p> <p>DRIVE BIT 1/4 S2 ALLOY STEEL STANDARD</p>
<p>POWER SQUARE</p>  <p>TXDDPSQ</p> <p>DRIVE BIT 1/4 S2 ALLOY STEEL STANDARD</p>	<p>POWER TRILOBULAR</p>  <p>TXDDPTR</p> <p>DRIVE BIT 1/4 S2 ALLOY STEEL STANDARD</p>	<p>POWER TORX</p>  <p>TXDDPTX</p> <p>DRIVE BIT 1/4 S2 ALLOY STEEL STANDARD</p>	<p>EZBIT DRILL BIT KIT</p>  <p>TXDEZPK</p> <p>PRE-DRILL & COUNTERSINK</p>		<p>EZBIT DRILL BIT REPLACEMENT</p>  <p>TXDEZRK</p> <p>PRE-DRILL & COUNTERSINK</p>	
<p>MAGNET BOOSTER</p>  <p>TXDMB</p> <p>DRIVE BIT 1/4 MAGNETIC BOOSTER</p>	<p>NEW WING NUT TENSIONER</p>  <p>TXDDPWN</p> <p>DRIVE BIT 1/4 S2 ALLOY STEEL STANDARD</p>		<p>Wing Nut Tensioner</p> <p>Used to tension HDG Strap Tensioner GSTMGFW30.</p> 			



RiVX®

Dome and countersunk rivets

RIVET DOME HEAD OPEN R9P73OAS ALUM 5052 STEEL ZP	RIVET DOME HEAD OPEN R9P73O6S ALUM 5056 STEEL ZP	RIVET DOME HEAD OPEN R9P73OAA ALUM 5052	RIVET DOME HEAD OPEN R9P73OMS MONEL STEEL ZP	RIVET DOME HEAD OPEN R9P73OSS STEEL ZP	RIVET DOME HEAD OPEN R0473OLL 304 STAINLESS STEEL	RIVET DOME HEAD OPEN R0473OLS 304 STAINLESS STEEL STEEL ZP
RIVET DOME HEAD OPEN R1673OLL 316 STAINLESS STEEL	RIVET DOME HEAD LARGE FLANGE R9P73LAS ALUM 5052 STEEL ZP	NEW RIVET DOME HEAD LARGE FLANGE R0473LLL 304 STAINLESS STEEL	RIVET DOME HEAD SEALED R9P73TAP ALUMINIUM STEEL PHOS	RIVET DOME HEAD SEALED R9P73TCP COPPER STEEL PHOS	RIVET DOME HEAD SEALED R9673T6S ALUM 5056 STEEL ZP	RIVET DOME HEAD SEALED R0473TLL 304 STAINLESS STEEL
RIVET DOME HEAD PEEL R9673P6S ALUM 5056 STEEL ZP	RIVET DOME HEAD MULTI-GRIP R9P73MAS ALUM 5052 STEEL ZP	RIVET CSK OPEN R9P72OAS ALUM 5052 STEEL ZP	RIVET CSK OPEN R9P72OMS MONEL STEEL ZP	NEW RIVET CSK OPEN R9P72OSS STEEL ZP	RIVET CSK OPEN R0472OLL 304 STAINLESS STEEL	NEW RIVET CSK SEALED R9P72TAP ALUMINIUM STEEL PHOS



NEW

Rivet Nuts

<p>NEW RIVET NUT FLAT RND KNURL OPEN</p> <p>316</p>  <p>NR16PFKOM</p> <p>316 STAINLESS STEEL</p>	<p>NEW RIVET NUT FLAT RND KNURL OPEN</p>  <p>NRALPFKOM</p> <p>ALUMINIUM</p>	<p>NEW RIVET NUT FLAT RND KNURL OPEN</p>  <p>NRMSZFKOM</p> <p>Z/P</p>
--	---	---

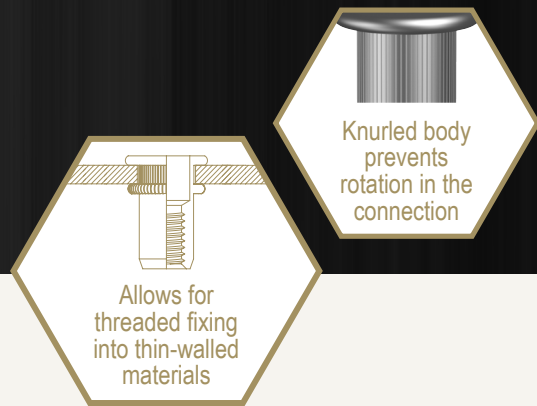

Rivet Head Types

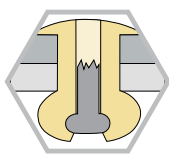

DOME HEAD OPEN

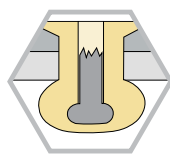

COUNTERSUNK SEALED

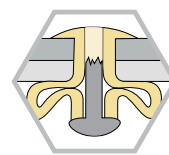

DOME HEAD TRIFORM

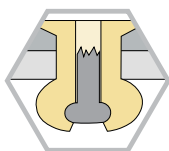

COUNTERSUNK OPEN

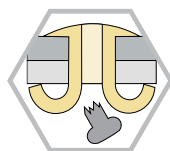

DOME HEAD PEEL

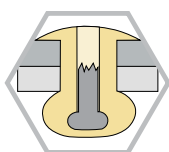

DOME HEAD SEALED

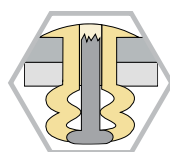

DOME HEAD MULTI-GRIP

